

# INFANTASTIC Przewijak 113 x 53 x 101 cm

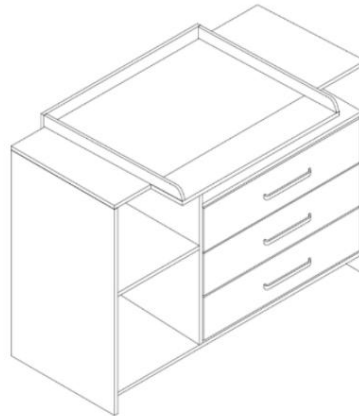

Gratulujemy zakupu licznika w naszej firmie. Aby licznik służył Państwu przez długi czas i spełniał Państwa oczekiwania, prosimy o zapoznanie się z poniższą instrukcją przed użyciem, a następnie zachowanie jej na przyszłość.









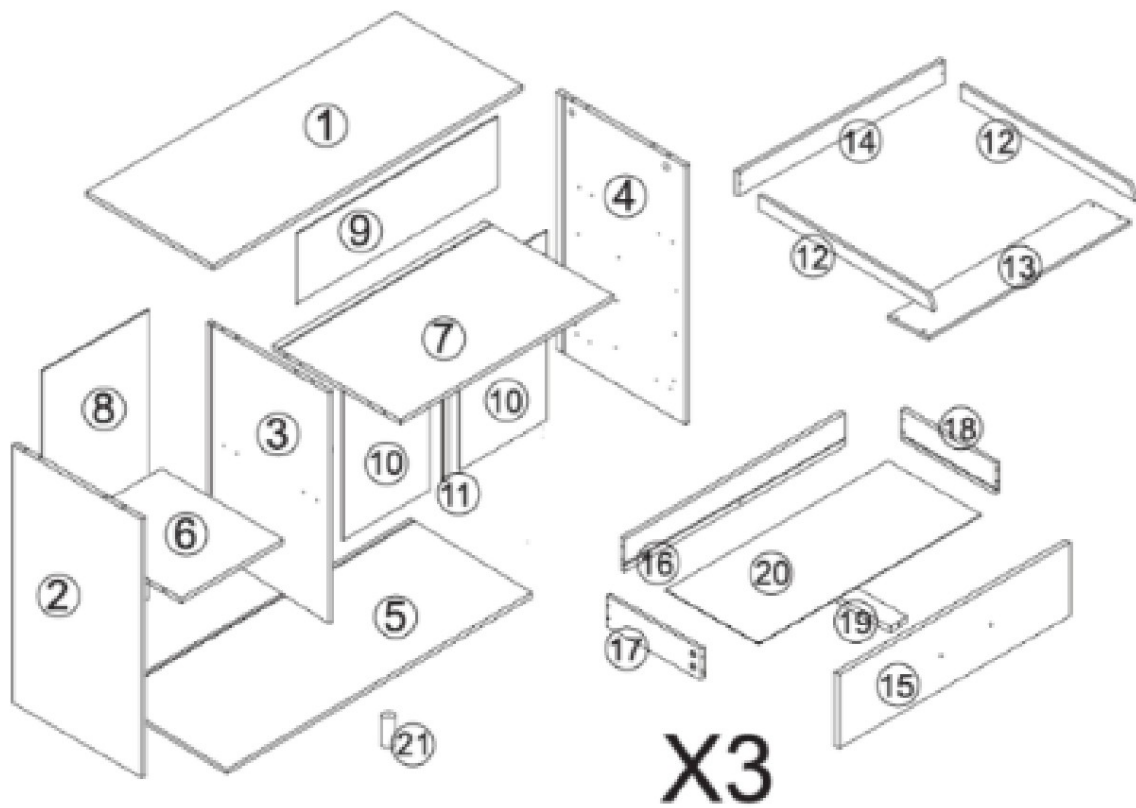







Jeżeli pożyczasz lub oddajesz komuś licznik, zawsze przekazuj go tej osobie wraz z niniejszą instrukcją.

Produkt nie jest przeznaczony do użytku komercyjnego.

- Produkt może składać wyłącznie osoba dorosła. • Przed montażem sprawdź, czy wszystkie części są obecne i nieuszkodzone. • Jeśli po rozpakowaniu wykazuje jakiegokolwiek wady, nigdy go nie montuj i natychmiast skontaktuj się z nami handel. Zbudowanie licznika z uszkodzonych części może skutkować uszczerbkiem na zdrowiu ludzi lub szkodami w mieniu, za które dostawca nie ponosi odpowiedzialności.
  - Nie zalecamy używania wiertarek/wkrętarek akumulatorowych, gdyż mogą one uszkodzić blat. Używaj wyłącznie śrubokrętów ręcznych.
  - Upewnij się, że wszystkie części są prawidłowo zamocowane i regularnie sprawdzane. • Nie wystawiaj ich na bezpośrednie działanie promieni słonecznych lub deszczu. Może to przyspieszyć deformację i odbarwienie lub spowodować pęknięcie.
  - Do konserwacji używaj wilgotnej szmatki.
  - Nie stawiać gorących przedmiotów (gorących napojów) bezpośrednio na powierzchni. • Nie używaj ani nie przechowuj w pobliżu otwartego ognia lub łatwopalnych chemikaliów.
  - Nie stój ani nie siadaj na blacie. •
- Uniemożliwiaj dzieciom wspinanie się na blat i schodzenie z niego. • Nigdy nie zostawiaj dzieci bez opieki.
- Jeśli nie używasz produktu, przechowuj go w suchym miejscu. •
- Odpowiednie wyłącznie dla dzieci poniżej 12 miesięcy o maksymalnej wadze 15 kg. •
- Nigdy nie wymieniaj uszkodzonych lub zużytych części na części pochodzące z innych produktów.
- 





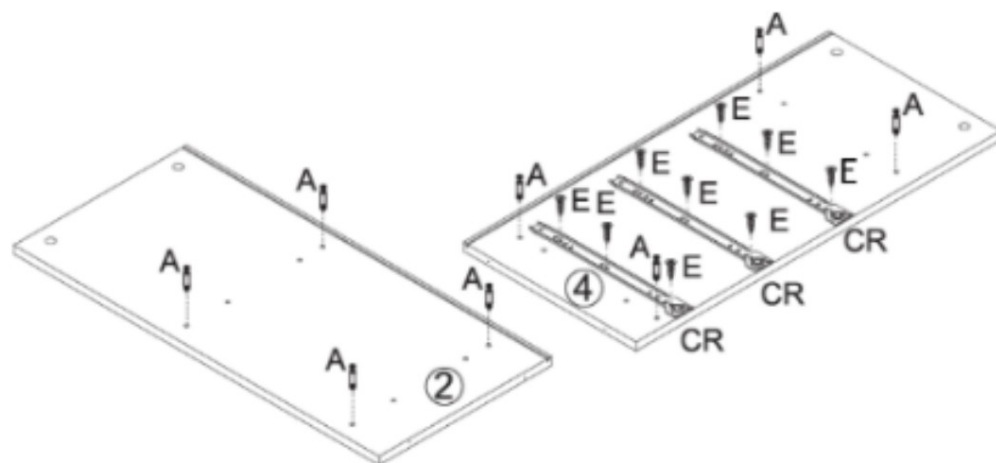

			 4 x 35mm	 3 x 12mm					
A	X33	B	X33	C	X20	D	X27	E	X36
			 4 x 12mm						
F	X6	G	X3	H	X4	I	X1	J	X1
									
K	X1	CL	X3	CR	X3	DL	X3	DR	X3
	 3 x 14mm								
P	X12	Q	X12						

1



		
A	X8	E X9 CR X3

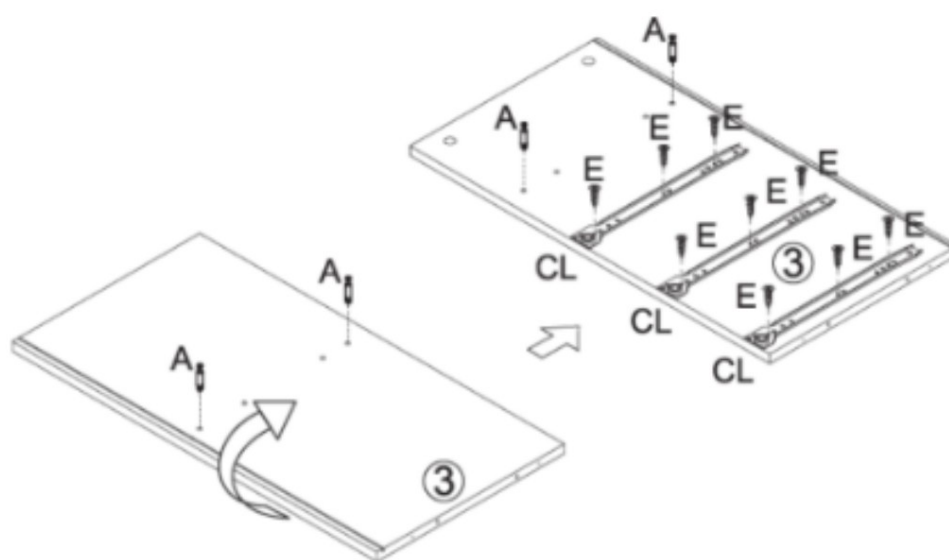

2



		
A	X4	E X9 CL X3

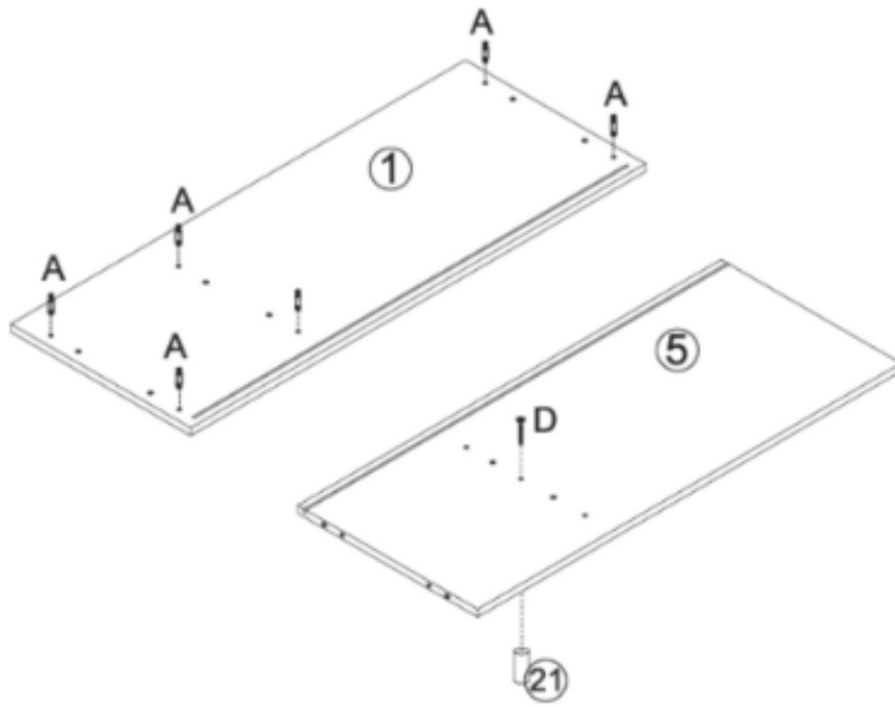

3



	
D	X1
	
A	X6

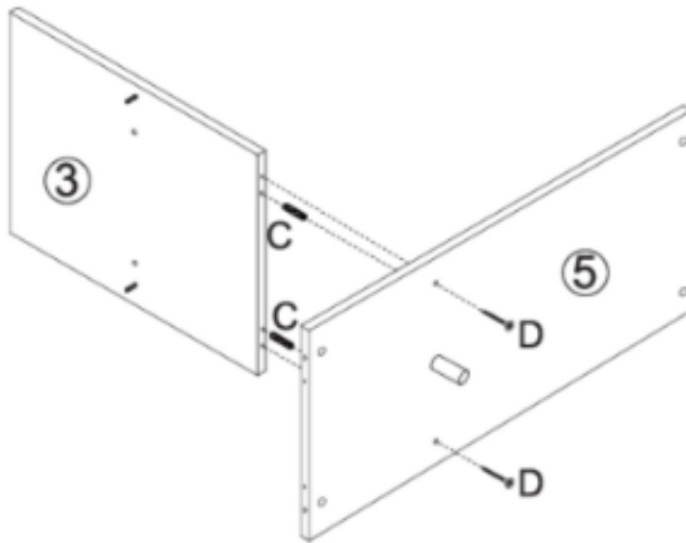

4



			
C	X2	D	X2

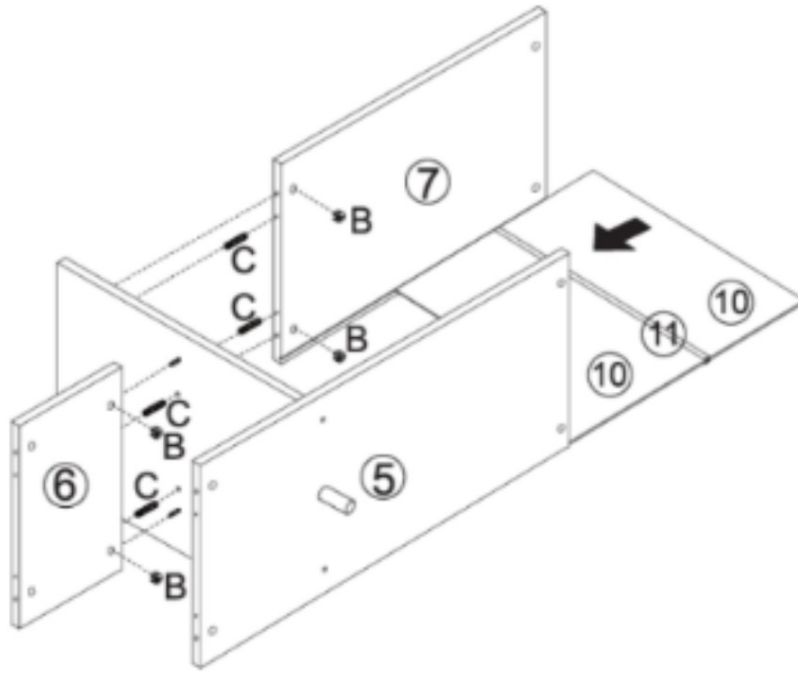

5

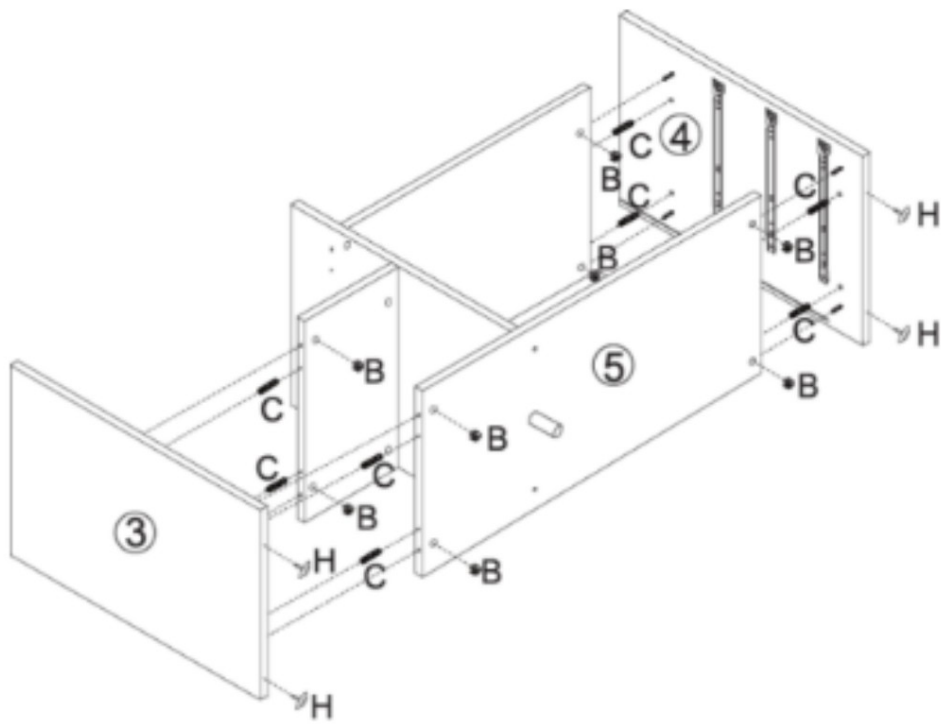

	
B	X4
	
C	X4

6





	
B	X8
	
C	X8
	
H	X4

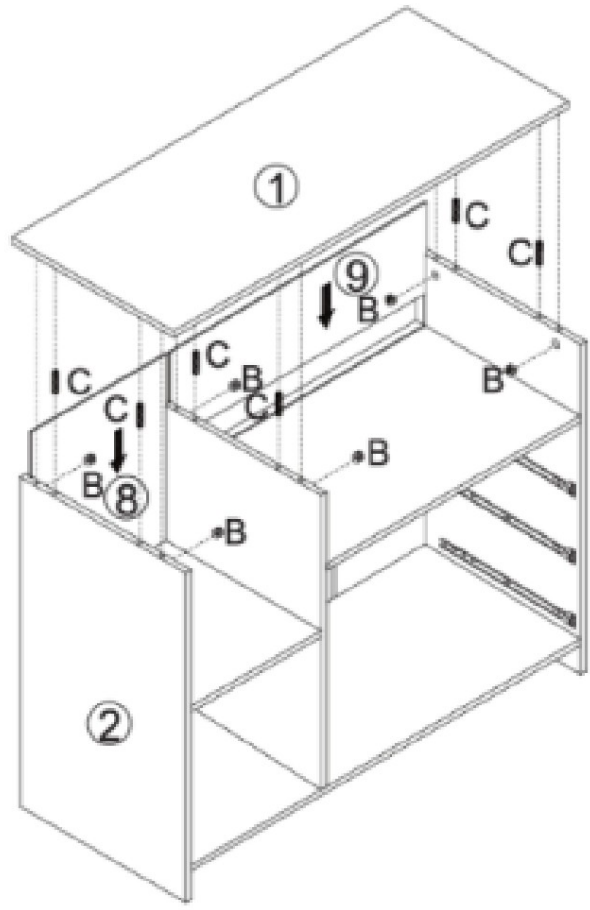

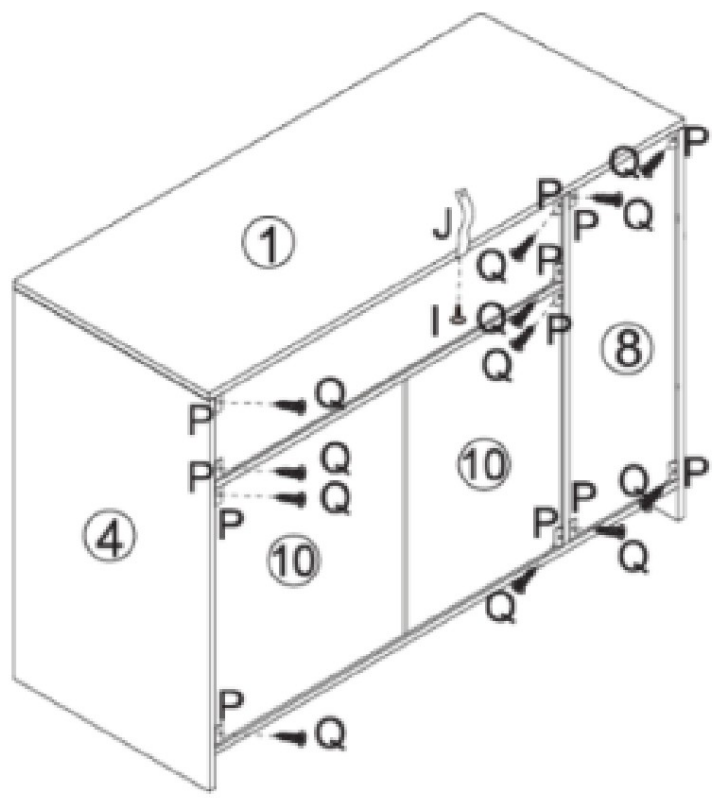

7



8



	
B	X6
	
C	X6

	
I	X1
	
J	X1
	
P	X12
	
Q	X12

9

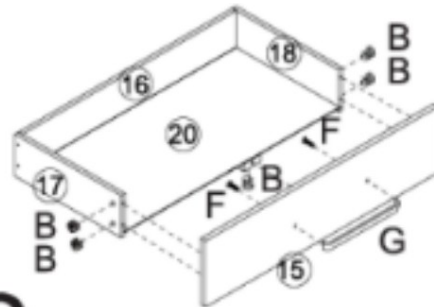
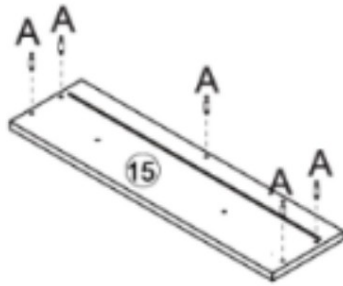
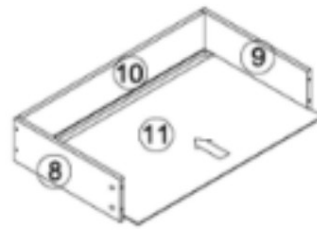
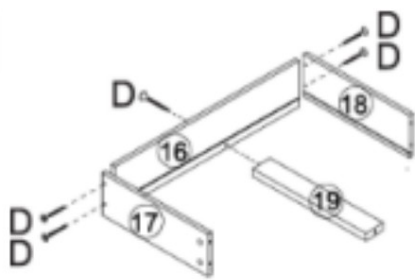

X3

	A	X 15
	B	X 15
	D	X 15
	F	X 6
	G	X 3

10

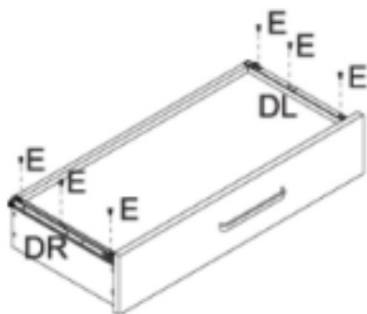

X3

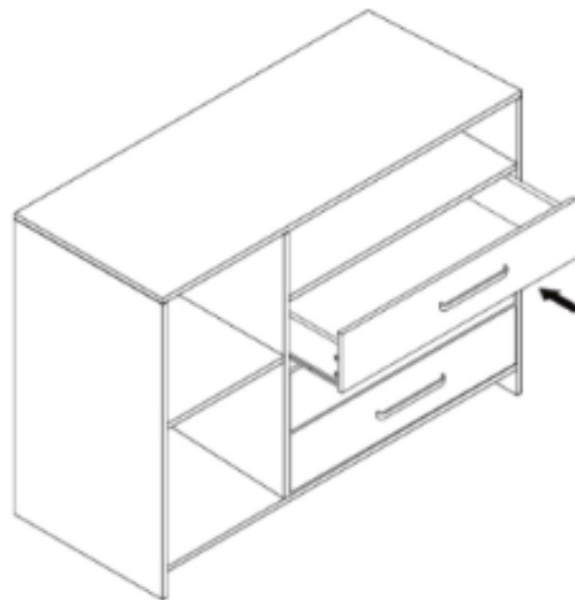

	E	X 18
	DL	X 3
	DR	X 3

11

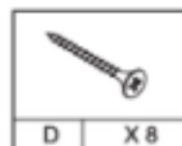
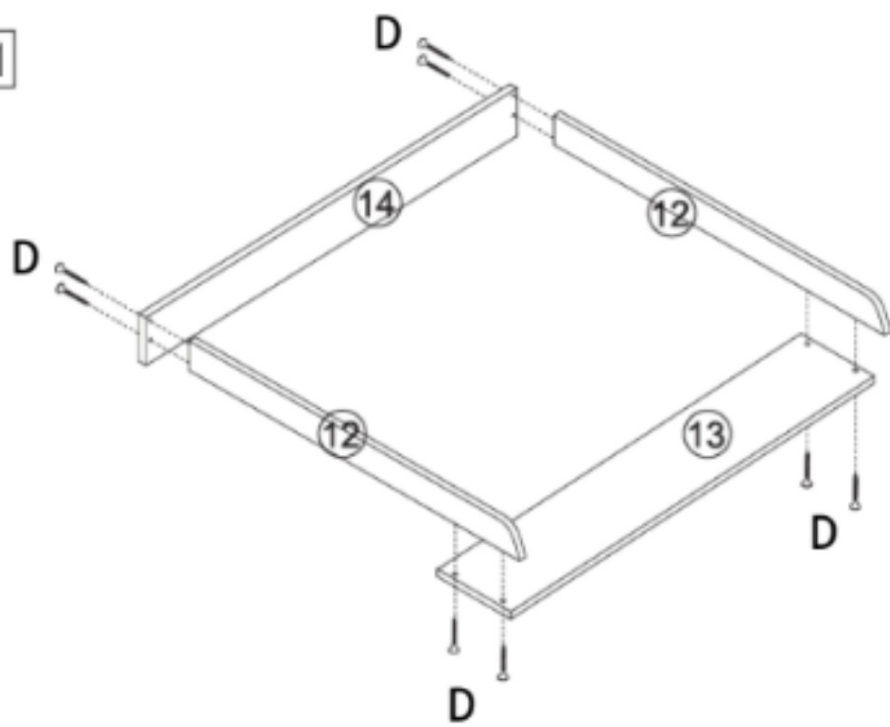

12

